



CT243011S Ceiling mount turn

Article number (SKU)
Colour

7955084
Silver

Key Benefits

- Stylish high-end design
- Easy install
- Rotatable

Ceiling mount kit CT243011

Display size: Fitment: 100x100Max. load: 30 kg - 66 lbs Kit consists of: • 1x PUC 1045 Ceiling plate turn and tilt • 1x PUC 2430 Pole 300cm • 1x PFI 3015 Display interface

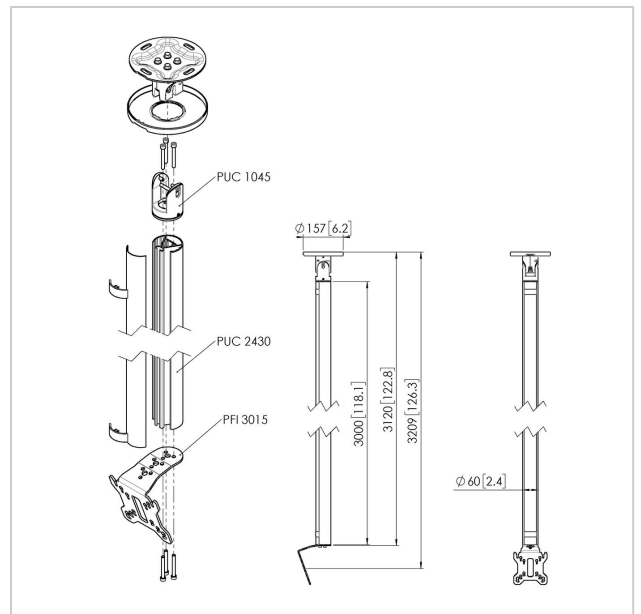



CT243011S Ceiling mount turn

www.vogels.com

VOGEL'S HOLDING BV 2019 (c) All rights reserved.
Subject to printing errors, technical and price amendments.
Date: 2020-08-26

Specifications

Product type number	CT243011	Min. horizontal hole pattern (mm)	50
Article number (SKU)	7955084	Min. screen size (inch)	10
Colour	Silver	Min. vertical hole pattern (mm)	50
EAN single box	8712285347108	Orientation	Landscape / Portrait
Length	3269	Universal or fixed hole pattern	Fixed
Width	130		
Depth	135		
TÜV certified	Yes		
Tilt	Tilt up to 20°		
Turn	Up to 360°		
Guarantee	5 years		
Max. weight load (kg)	30		
Max. bolt size	M4		
Max. height of interface (mm)	141		
Max. width of interface (mm)	130		
Ceiling types	Flat / inclined ceiling		
Height options	Fixed height		
Levelling function	Post-installation horizontal levelling		
Max. distance to ceiling - center display (mm)	3209		
Max. horizontal hole pattern (mm)	100		
Max. screen size (inch)	32		
Max. vertical hole pattern (mm)	100		