



CT240844S Ceiling mount turn

Article number (SKU)
Colour

7955104
Silver

Key Benefits

- Stylish high-end design
- Easy install
- Rotatable

Ceiling mount kit CT240844

Display size: Fitment: 400x400Max. load: 40 kg - 88 lbs Kit consists of: • 1x PUC 1045 Ceiling plate turn and tilt • 1x PUC 2408 Pole 80 cm • 1x PFB 3405 Interface bar • 1x PFS 3304 Interface display strips

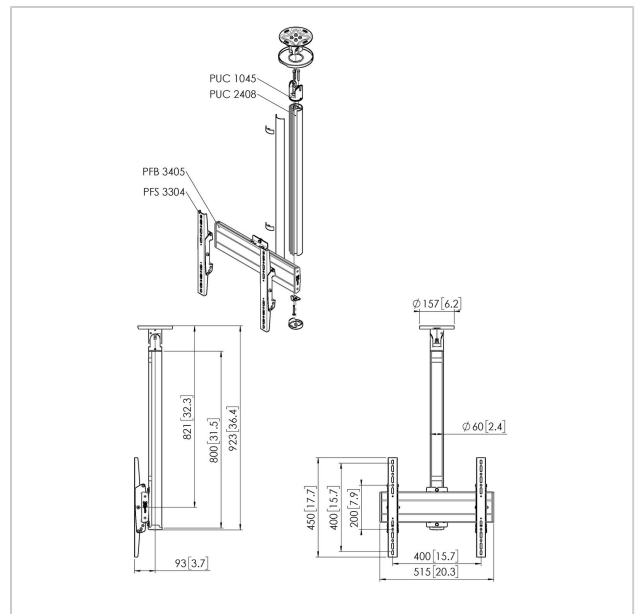

CT240844S Ceiling mount turn



VOGEL'S HOLDING BV 2019 (c) All rights reserved.
 Subject to printing errors, technical and price amendments.
 Date:2020-08-26

www.vogels.com

Specifications

Product type number	CT240844	Min. horizontal hole pattern (mm)	100
Article number (SKU)	7955104	Min. vertical hole pattern (mm)	100
Colour	Silver	Orientation	Landscape / Portrait
EAN single box	8712285347184	Universal or fixed hole pattern	Universal
Length	1046		
Width	515		
Depth	172		
TÜV certified	Yes		
Tilt	Tilt up to 20°		
Turn	Up to 360°		
Guarantee	5 years		
Max. weight load (kg)	40		
Min. hole pattern	100mm x 100mm		
Max. hole pattern	400mm x 400mm		
Max. bolt size	M8		
Max. height of interface (mm)	450		
Max. width of interface (mm)	515		
Ceiling types	Flat / inclined ceiling		
Height options	Fixed height		
Max. distance to ceiling - center display (mm)	821		
Max. horizontal hole pattern (mm)	400		
Max. screen size (inch)	65		
Max. vertical hole pattern (mm)	400		