



CT240811 B Ceiling mount turn

Article number (SKU)
Colour

7955010
Black

Key Benefits

- Stylish high-end design
- Easy install
- Rotatable

Ceiling mount kit CT240811

Display size: Fitment: 100x100Max. load: 30 kg - 66 lbs Kit consists of: • 1x PUC 1045 Ceiling plate turn and tilt • 1x PUC 2408 Pole 80 cm • 1x PFI 3015 Display interface

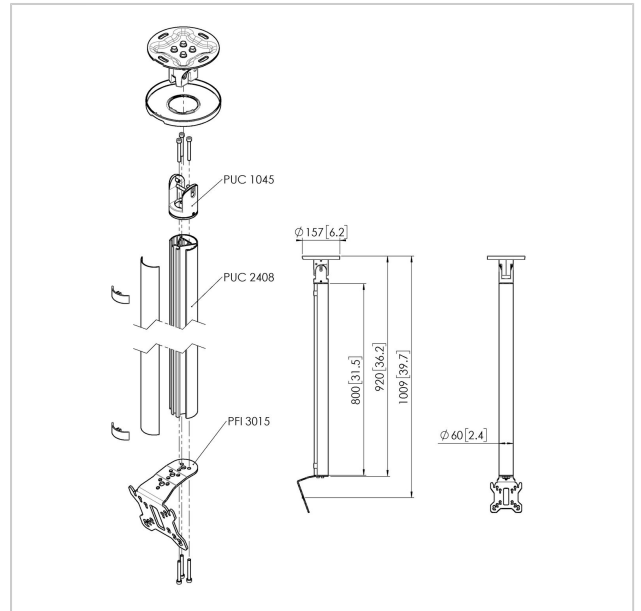



CT240811 B Ceiling mount turn

www.vogels.com

VOGEL'S HOLDING BV 2019 (c) All rights reserved.
Subject to printing errors, technical and price amendments.
Date:2020-08-26

Specifications

Product type number	CT240811	Min. horizontal hole pattern (mm)	50
Article number (SKU)	7955010	Min. screen size (inch)	10
Colour	Black	Min. vertical hole pattern (mm)	50
EAN single box	8712285346880	Orientation	Landscape / Portrait
Length	934	Universal or fixed hole pattern	Fixed
Width	130		
Depth	135		
TÜV certified	Yes		
Tilt	Tilt up to 20°		
Turn	Up to 360°		
Guarantee	5 years		
Max. weight load (kg)	30		
Max. bolt size	M4		
Max. height of interface (mm)	141		
Max. width of interface (mm)	130		
Ceiling types	Flat / inclined ceiling		
Height options	Fixed height		
Levelling function	Post-installation horizontal levelling		
Max. distance to ceiling - center display (mm)	1009		
Max. horizontal hole pattern (mm)	100		
Max. screen size (inch)	32		
Max. vertical hole pattern (mm)	100		