

NOVUS TSS folding arm II



- High quality infinitely height adjustable 2-part monitor support arm
- Easy mounting of the monitor by quick release with one hand operation, suitable for attachment standard 75/100
- Mounting of flat screens up to 10 kg
- Restrict movement by tightening the joints
- Ergonomic monitor setting by various joints
- Range: 450 mm
- Perfect cable management by cable clips
- In high-quality aluminium and metal
- Removable clamping grips for protection from theft
- Obligatory supplement is a TSS column

Version	Art.No.	EAN Code
 silver / anthracite	964+0119+000	4009729046982



The weight indicates the maximum load-bearing capacity of the supporting element or the maximum weight of an attachable monitor in kilograms.



The mounting has the mentioned reach in mm.



Novus offers a warranty of 5 years when handled in a proper manner.



The quality statement „German Engineering“ ensures that a product was developed according to German quality standards by our engineering experts. All Novus products carrying the „German Engineering by Novus“ signet are manufactured in our own plants around the world by our own workforce, managed and supervised by our headquarters in Germany.



This machine bears the GS approval of product safety.

NOVUS TSS folding arm II



thanks to their multi-part articulated design, TSS folding arms can be turned horizontally through any distance to provide the best possible monitor viewing angle around the column. Depending on column attachment

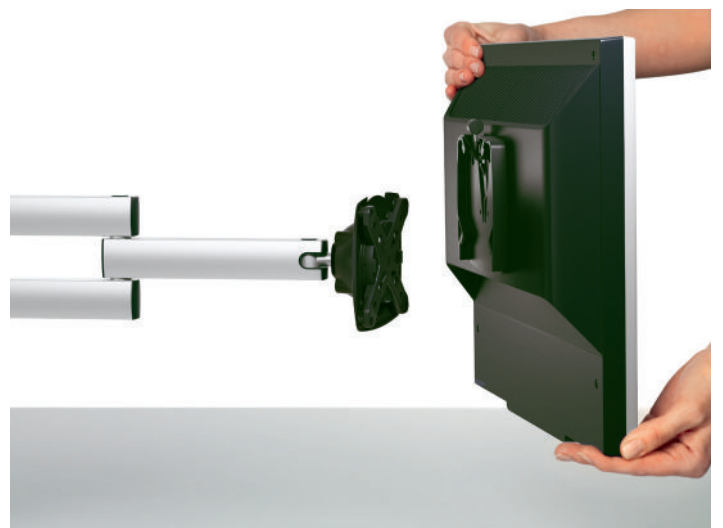

with NOVUS Quick Release for quick and easy monitor change without tools

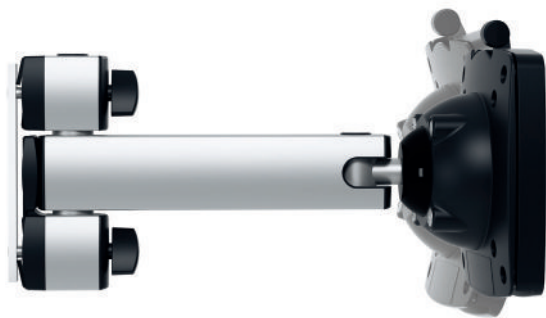

ball-joint for flexible and precise positioning of the monitor



the cable holder in the folding arm ensures a safe and tidy cable management

NOVUS TSS column with system clamp 1 (14-40mm)



- Aluminium column with four slots and system clamp 1
- Table mounting with system clamp 1 for a desktop thickness of 14-40 mm
- Available in lengths: 445 mm and 545 mm
- Includes two cable clips
- Suitable for all TSS support elements





Version	Art.No.	EAN Code
  silver	961+0609+000	4009729033661
  silver	961+0639+000	4009729042151



Table mounting with system clamp 1 for a desktop thickness of 14-40 mm



all items with universal clamp 1 can be attached to the product



Novus offers a warranty of 5 years when handled in a proper manner.



The quality statement „German Engineering“ ensures that a product was developed according to German quality standards by our engineering experts. All Novus products carrying the „German Engineering by Novus“ signet are manufactured in our own plants around the world by our own workforce, managed and supervised by our headquarters in Germany.



This machine bears the GS approval of product safety.