

WL35-750BL14

NEOMOUNTS HEAVY DUTY TV WALL MOUNT

SPECIFICATIONS

GENERAL

Min. screen size*	32 inch
Max. screen size*	75 inch
Max. weight	100 kg (per screen)
Screens	1
VESA minimum	100x100 mm
VESA maximum	400x400 mm
Distance to wall	9,3 cm

FUNCTIONALITY

Type	Tilt
Height adjustment	1 cm
Lockable	Lockable - Padlock not included
Tilt (degrees)	+15°, -15°
Height	43 cm
Width	48,6 cm
Depth	9,3 cm
Adjustment type	Manual

INFORMATION

Color	Black
Main material	Steel
Warranty	5 year
EAN code	8717371443542

*Please note: The inch sizes stated are just an indication, combined with the weight and VESA sizes. The maximum weight and VESA size are absolute restrictions for the products and should not be exceeded.

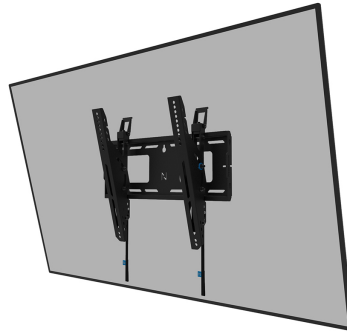

Neomounts



Neomounts

Neomounts WL35-750BL14 tiltable wall mount for 43-75" screens - Black

The Neomounts WL35-750BL14 LEVEL is the ultimate tiltable solution for securely mounting an interactive or heavy weight display up to 75" with a maximum capacity of 100 kg. The toolless tilt adjustment (+15°/-15°) allows you to create the optimum viewing angle. This heavy-duty wall mount features a sturdy high profile wall plate and is engineered for stability and precision, ensuring your screen is securely mounted even on uneven surfaces. The mount features individual adjustable brackets (10 mm) for securely adjusting the display height or levelling it.

The LEVEL-750 wall mount has a profile of 9,3 cm and is suitable for screens that meet VESA hole pattern 100x100 to 400x400 mm. Its quickly connectable wall plate allows for multiple screen mounting. Additionally, the wall plate is designed with specific cut-outs for wall sockets and securing devices and cables. It features various perforated holes for easy tie-wrap cable fixing and provides space for cable storage, ensuring a clean and tidy finishing.

The WL35-750BL14 includes a safe and practical pull & release system, allowing you to quickly attach and detach the display in a safe and secure manner. The tilt-lock prevents the display from tilting upwards when attaching it on or detaching it from the mount to enable a safe install. It is possible to lock the bracket using a padlock (not included) for extra screen security.

For a simple and effective storage, an optionally available, AV-rack can be installed to the left or right side of the mount.

WL35-750BL14

NEOMOUNTS HEAVY DUTY TV WALL MOUNT

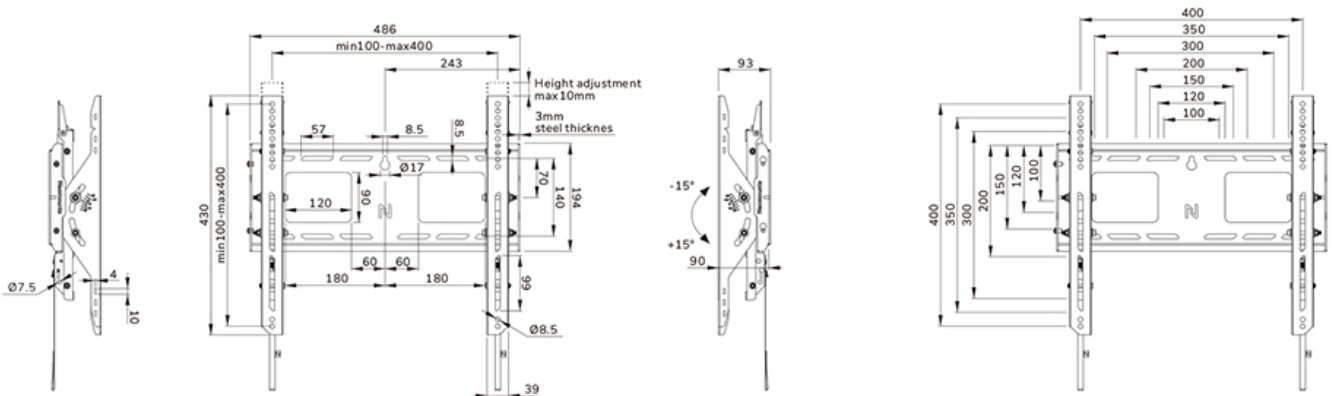

Neomounts

Measuring unit: mm