

EVOline® Frame Dock



Supply EV0line U-Dock

Examples of supply modules
for circuit 1 and 2
(IT circuit Red)

Through the end cap LEFT
and / or end cap
RIGHT

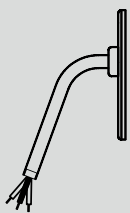

End cap to
individually
use with cable
and end splices.

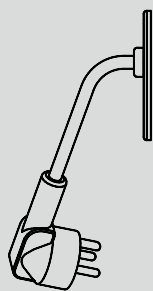

End cap with cable
and plug.
Variants available.

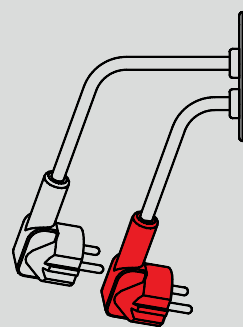

End cap with two
cables and plugs.
Variants available.

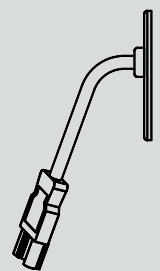

End cap with cable
and connectors.

EVOLine® Frame Dock

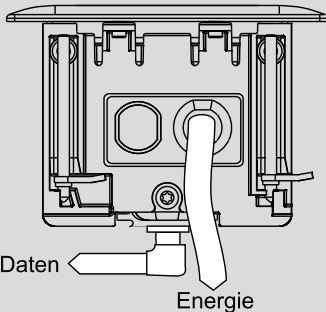

In case of power and data: Power out of the end cap, data out of the bottom of the profile.

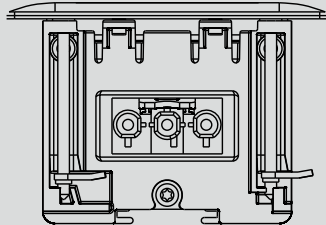

End cap with plug connectors GST 18/3-plug, power input

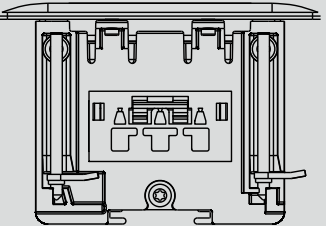

End cap with WAGO Winsta plug power input.

The EVOLine® Frame Dock offers a lot of new options:

Not only the nearly unlimited variants of combination out of our large module collection, also the multitude of application make the EVOLine® Frame Dock to an universal problem solver.

EVOLine® U-Dock Individual

Just choose the modules and the configuration!
With the modular design of EVOLine® U-Dock you have the opportunity to customise your model the way you wish.

How to order
Page 152-153

Screw cover



Silver



Black

Surface variations



Silver

other surface variations on request.



Socket modules

Page 200 -219



Data modules

Page 220 - 239



Multimedia modules

Page 240 - 255



Pushbutton and switch modules

Page 256 - 261



Protection modules

Page 262 - 265

1

**Selection
EVOLine®
Frame Dock
profile**
Page 155



**Empty housing EVOLine®
Frame Dock**

Order number:
9331 2180 0000

2

**Selection
EVOLine®
modules**
Page 201 - 271



3 x socket VDE
Order number:
9330 0090 0000

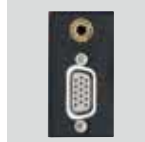

**Combination
module
VGA / Audio**
Order number:
9330 7920 0000



USB module
Order number:
9330 1040 0000

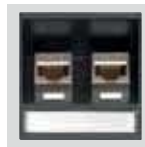

**Data module
CAT 6**
Order number:
9330 3920 0000

3

**Selection
EVOLine®
supply cable**
Page 220 - 221



**Supply cable
modules**
Order number:
9330 2680 0000
9330 8960 0000

Desired end cap
with or without
mounting tabs,
Please specify

All cable lengths are measured from the connection point and mounting position of the modules in the profile.

**Please note for
module selection:**

**the profile number determines
the permissible combination of
modules and profiles.**

EVOLine® Profile type	No.
EVOLine® Dock / R-Dock	1
EVOLine® U-Dock / Frame Dock	2
EVOLine® Port	3
EVOLine® Port Lounge	4
EVOLine® Vertical	5
EVOLine® SubDesk	6
EVOLine® Caddy	7
EVOLine® FlipTop	8
EVOLine® V-Dock	9

4

Your
EVOLine®
U-Dock
Individual

5

Selection
EVOLine®
accessories
Page 281 - 287



EVOLine®
Cable-
Management
to protect
your cable
distribution
Page 272- 279

Ordering information:

After receiving your order a product drawing will be sent to you, that you release with your signature, thus avoiding wrong orders.

Our general conditions of sale apply for all orders.
www.schulte.com

Subject to technical changes.

The goods are not marked with EAN-codes.
If required, please order separately.

EVoline® Frame Dock

Article	Picture	Specification	Type
<p>EVoline® Frame Dock SMALL with screw cover. Aluminium housing three sockets, 60°, 16 A, with contact protection of Germany, Austria * 3 m supply cable with plug, Power inlet in the back of the profile.</p>		<p>Silver anodized with Black screw cover</p>	<p>1596 1000 0900</p>
<p>EVoline® Frame Dock DATA SMALL with screw cover. Aluminium housing three sockets, 60°, 16 A, with contact protection of Germany, Austria * 3 m supply cable with plug, two modular couplings for patch cable RJ45 to RJ45, 1:1 interconnected CAT6 shielded. Power and data inlet in the back of the profile.</p>		<p>Silver anodized with Black screw cover</p>	<p>1596 1000 1000</p>
<p>EVoline® Frame Dock MEDIUM with screw cover. Aluminium housing four sockets, 60°, 16 A, with contact protection of Germany, Austria * 3 m supply cable with plug, Power inlet in the back of the profile.</p>		<p>Silver anodized with Black screw cover</p>	<p>1596 1000 1200</p>
<p>EVoline® Frame Dock MEDIUM with screw cover. Aluminium housing four sockets, 60°, 16 A, with contact protection of Germany, Austria * 3 m supply cable with plug, two modular couplings for patch cable RJ45 to RJ45, 1:1 interconnected CAT6 shielded. Power and data inlet in the back of the profile.</p>		<p>Silver anodized with Black screw cover</p>	<p>1596 1000 1300</p>

2) Appropriate socket types for international requirements can be found on page 203

EVOLine® Frame Dock Individual

Article	Picture	Specification	Type
<p>Just combine the modules in the basic profile of your choice! Thanks to the modular design of the EVOLine® U-Dock, you have the option to compile an individual model according to your wishes.</p> <p>More information about „How to order EVOLine®“ See pages 152-153</p>		<p>Silver anodized with Black screw cover</p> <p>Silver anodized with Black screw cover</p>	<p>9331 2180 0000</p> <p>9331 2550 0000</p>