

Ergotron® 100 Series

Dimensional Illustrations

for low profile systems

Single Pivot with P/L

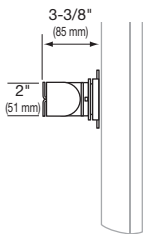

Double Pivot with P/L

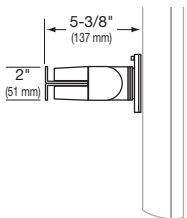

Keyboard/Laptop Pivot

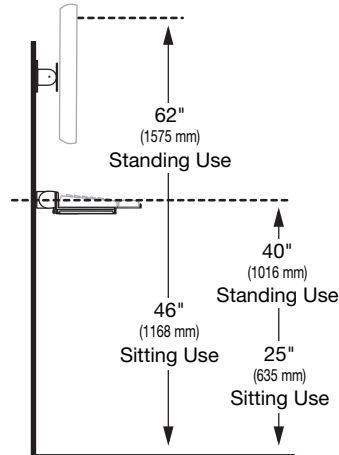
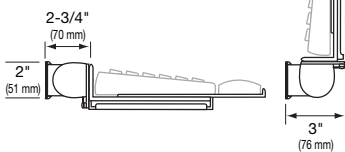

**100 Series
(Fixed Height)**

Note: Actual range of motion depends on mounting surface and size of monitor.

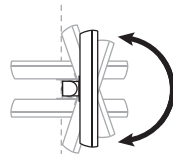

LCD tilts up to 180° forward/back

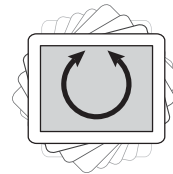

LCD rotates up to 360° portrait/landscape

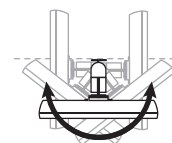

LCD pans up to 180° right/left

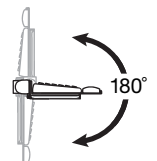

Keyboard tilts up to 180° forward/back

Single Pivot w/ P/L Interface

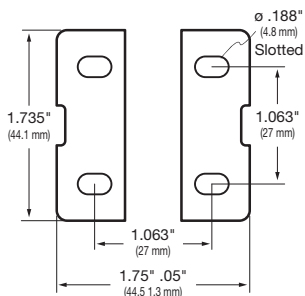

Double Pivot w/ P/L Interface

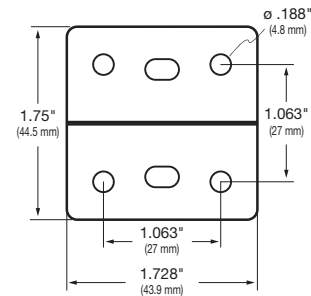

Keyboard/Laptop Pivot Interface

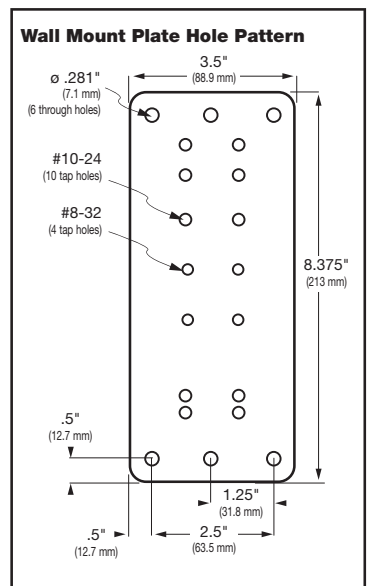
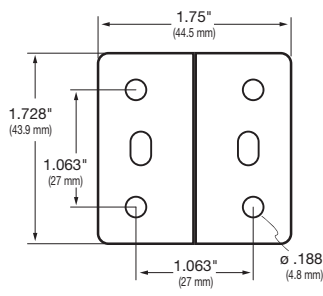

© 2010 Ergotron, Inc. rev. 11/10/2010 DIM-026 Content is subject to change without notification

Americas Sales and Corporate Headquarters

St. Paul, MN USA
(800) 888-8458
+1-651-681-7600
www.ergotron.com
sales@ergotron.com

EMEA Sales

Amersfoort, The Netherlands
+31 33 45 45 600
www.ergotron.com
info.eu@ergotron.com

APAC Sales

Tokyo, Japan
www.ergotron.com
apaccustomerservice@ergotron.com

Worldwide OEM Sales

www.ergotron.com
info.oem@ergotron.com

