

### Wall Mount Arm

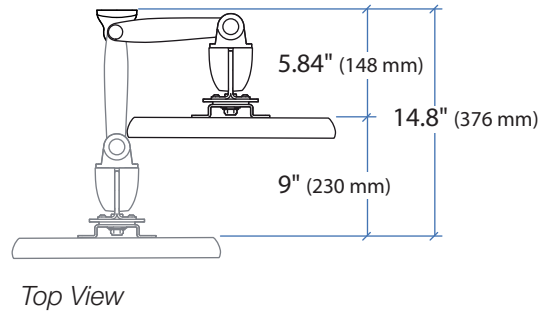

### Wall Mount Bracket

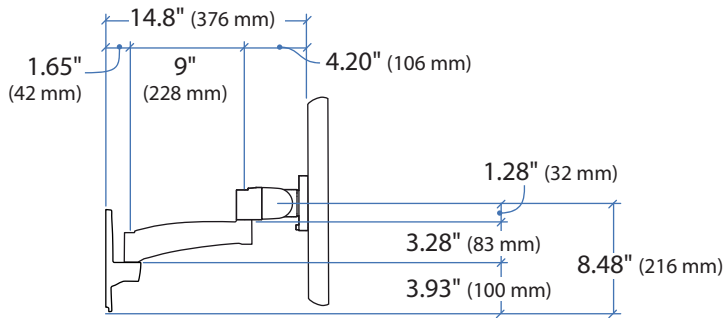
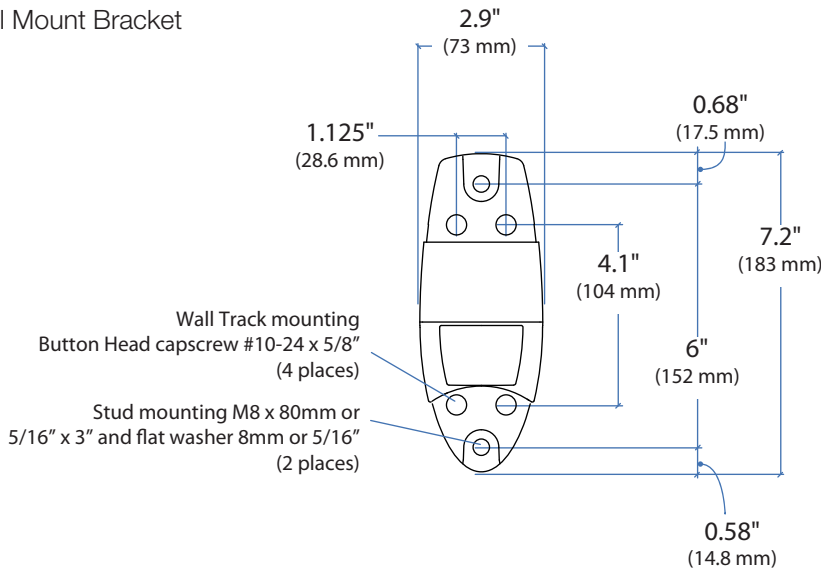

### Range of Motion

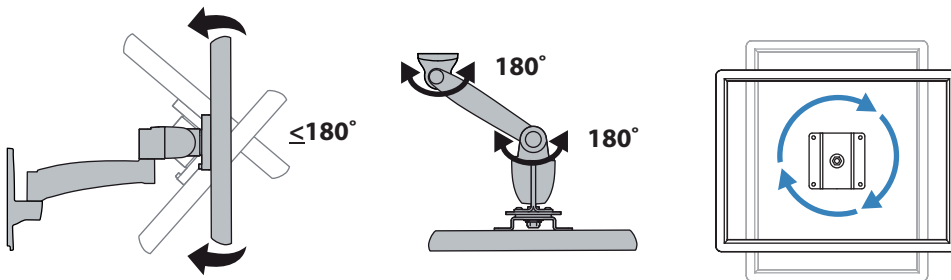

### Maximum Weight Capacity

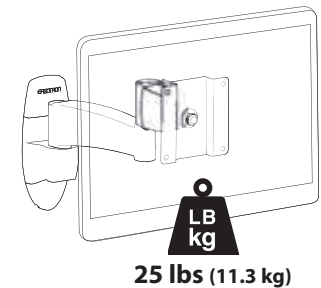

© 2013 Ergotron, Inc. rev. 07/22/2013 DIM-200 Arm1 Content is subject to change without notification

#### Americas Sales and Corporate Headquarters

St. Paul, MN USA  
 (800) 888-8458  
 +1-651-681-7600  
 www.ergotron.com  
 sales@ergotron.com

#### EMEA Sales

Amersfoort, The Netherlands  
 +31 33 45 45 600  
 www.ergotron.com  
 info.eu@ergotron.com

#### APAC Sale

Tokyo, Japan  
 www.ergotron.com  
 apaccustomerservice@ergotron.com

#### Worldwide OEM Sales

www.ergotron.com  
 info.oem@ergotron.com

