

WPMV100, 200

PROJECTOR WALL MOUNT
UCHWYT ŚCIENNY DO PROJEKTORA

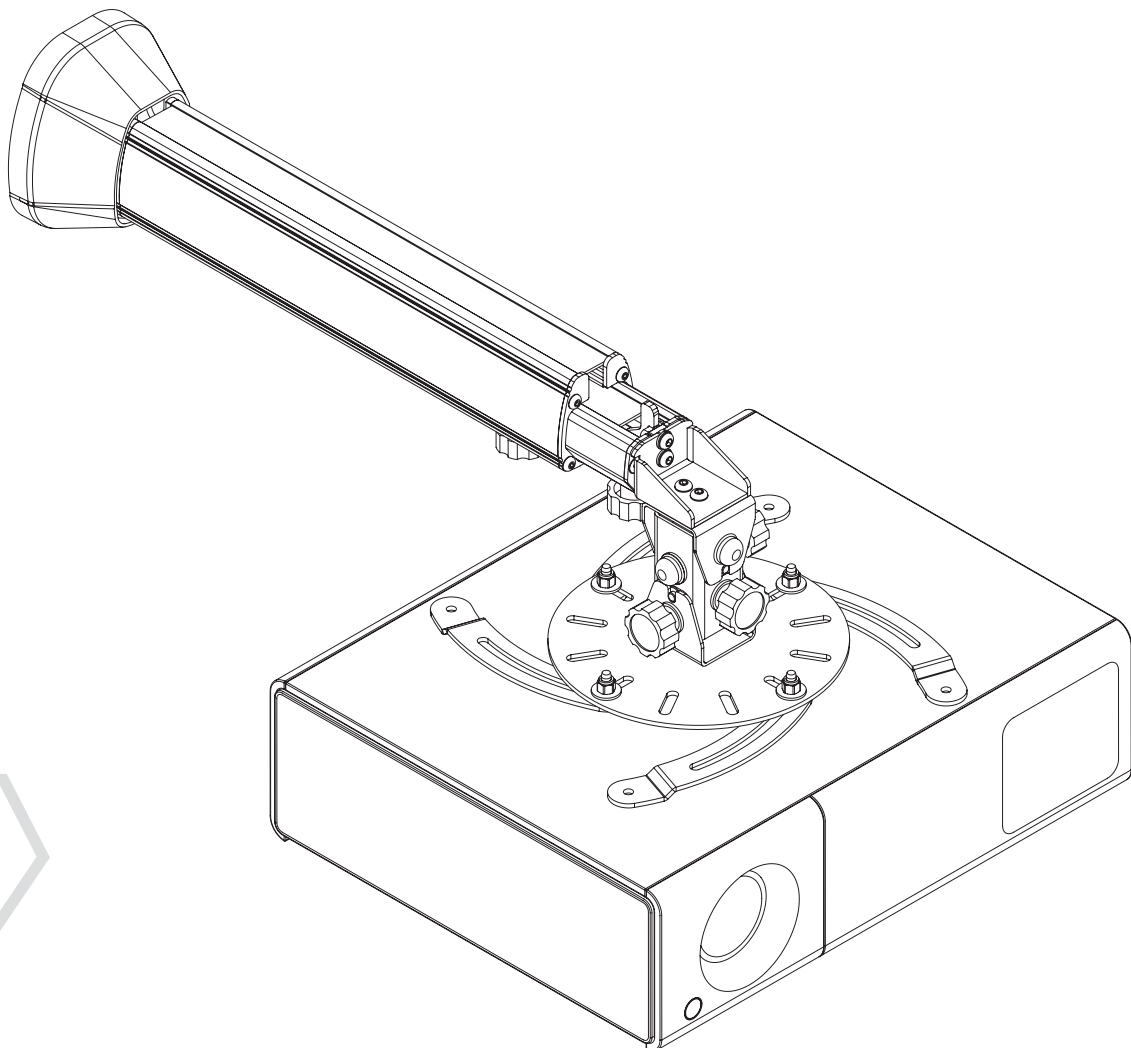

⚠ Warning

Please read this manual before starting the installation to ensure correct assembly. The assembly should be carried out in accordance with this manual by at least two fully qualified people. The EDBAK Company shall not be liable for any injuries or damage to material or property caused by incorrect assembly. Hence please ensure that:

- during the assembly all the instructions are followed carefully. Failure to do so may result in damage to the product or property, or even personal injury;
- before assembly you must ensure that there are no power cables, or water, sewage or gas pipes in the area of the ceiling where the mount is to be fixed;
- when attaching the projector to the mount, please ensure that the screws are of the correct length and diameter. In order to ensure the correct fit, use the plastic spacers supplied. Use of the wrong screws may result in permanent product damage. Extra caution should be taken with movable parts in order to avoid crushing or pinching your hands or fingers. The movable parts are identified in this manual.

The terms of the product guarantee are detailed in the guarantee card.

⚠ Ostrzeżenie

Przed rozpoczęciem montażu należy uważnie zapoznać się z instrukcją uchwytu oraz ekranu w celu zapewnienia prawidłowego montażu.

Prace montażowe powinny wykonywać co najmniej dwie osoby posiadające kwalifikacje w zakresie montażu zgodnie z niniejszą instrukcją. Firma EDBAK nie bierze odpowiedzialności za straty materialne oraz uszkodzenia mienia lub ciała, wynikające z nieprawidłowego montażu. Dlatego należy zawsze przestrzegać:

- w trakcie montażu dokładnie przestrzegać załączonej do produktu instrukcji montażowej, w przeciwnym razie może to prowadzić do zniszczenia sprzętu, a nawet uszkodzeń ciała,
- koniecznie przed montażem upewnić się, że pod powierzchnią ściany, na której będzie mocowany uchwyt nie ma kabli elektrycznych, rur wodnokanalizacyjnych lub instalacji gazowych,
- w trakcie montażu ekranu do uchwytu upewnić się, że użyte śruby są dobrze dobrane co do długości i średnicy. W celu idealnego dobrania długości śrub można skorzystać z dołączonych podkładek plastikowych. Zastosowanie niewłaściwych śrub grozi trwałym uszkodzeniem sprzętu,
- w miejscach wskazanych w instrukcji, w których są ruchome elementy uchwytu zachować szczególną ostrożność w celu uniknięcia przyciśnięcia, dłoni i palców. Warunki gwarancji wg załączonej do produktu karty gwarancyjnej.



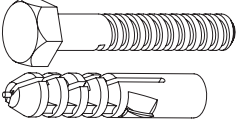
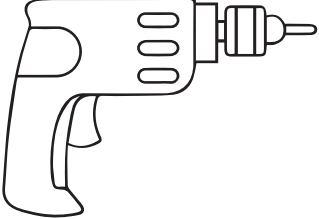

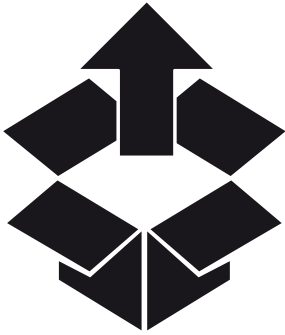

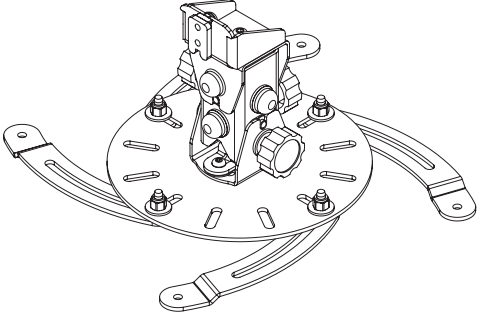
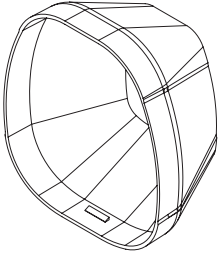
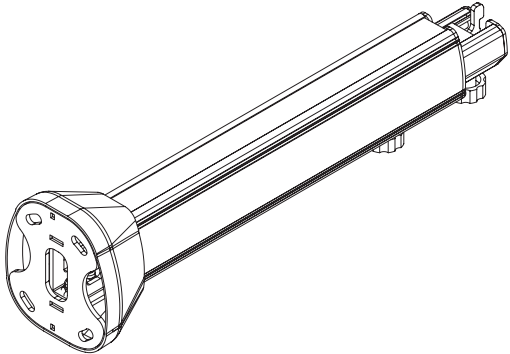
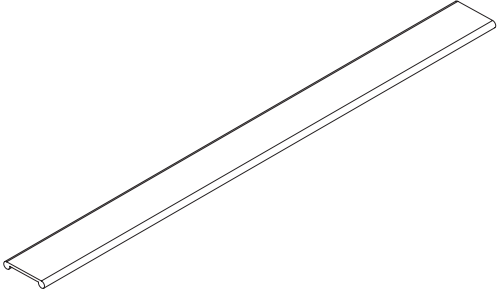

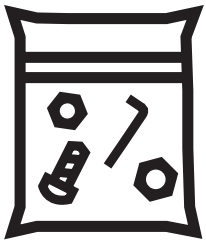













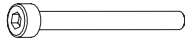

	AA	4x
	BB	1x

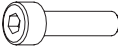
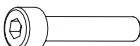
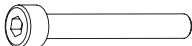

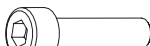
	<p>A</p>	<p>1x</p>
	<p>B</p>	<p>1x</p>
	<p>C</p>	<p>1x</p>
	<p>D</p>	<p>2x</p>



	fi6 x fi3,2 x 3	A01	4x
	fi6 x fi3,2 x 5	A02	4x
	fi6 x fi3,2 x 7,5	A03	4x
	fi8 x fi4,3 x 3	A04	4x
	fi8 x fi4,3 x 5	A05	4x
	fi8 x fi4,3 x 7,5	A06	4x
	fi8 x fi5,3 x 3	A07	4x
	fi8 x fi5,3 x 5	A08	4x
	M4 x fi12	A09	8x
	M5 x fi14	A10	4x
	M3 x 10	A11	4x
	M3 x 16	A12	4x
	M3 x 20	A13	4x

	M3 x 30	A14	4x
	M4 x 10	A15	4x
	M4 x 16	A16	4x
	M4 x 20	A17	4x
	M4 x 30	A18	4x
	M5 x 10	A19	4x
	M5 x 16	A20	4x
	M5 x 20	A21	4x
	M5 x 30	A22	4x
	2,5mm	A23	1x
	3mm	A24	1x
	4mm	A25	1x
	5mm	A26	1x

1.

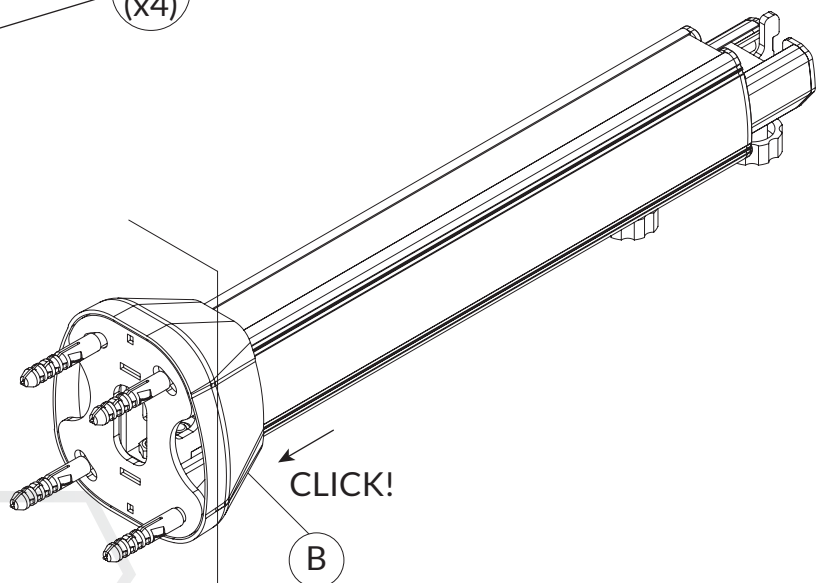
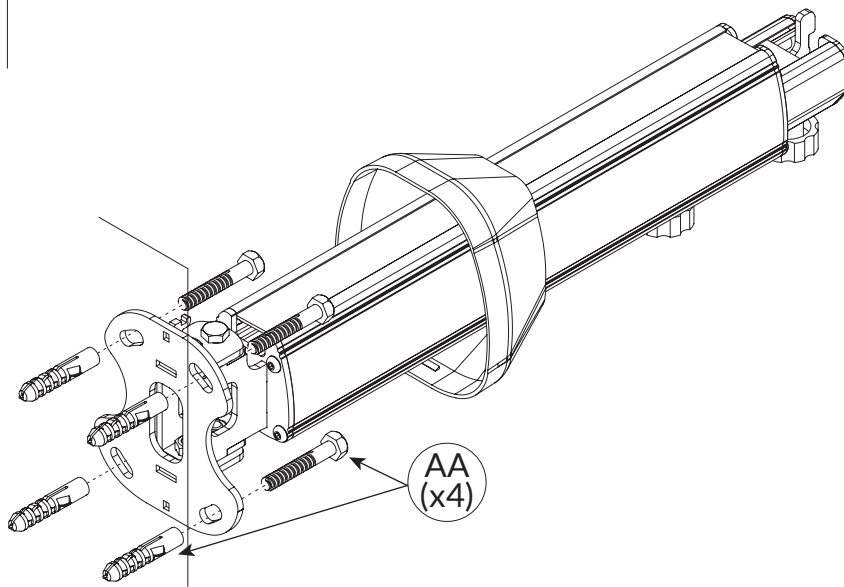
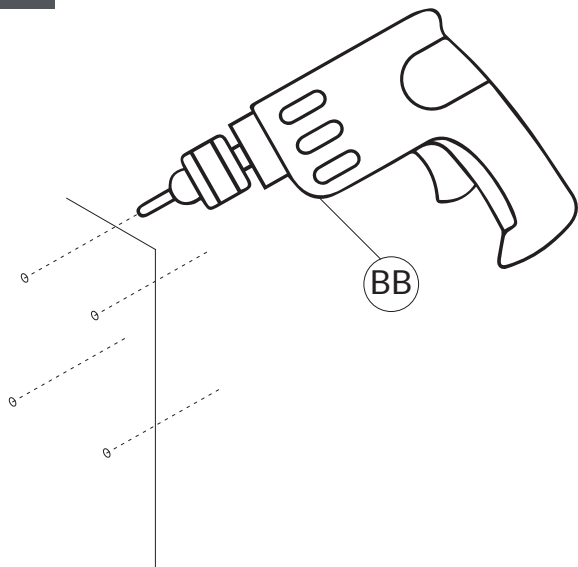

2.

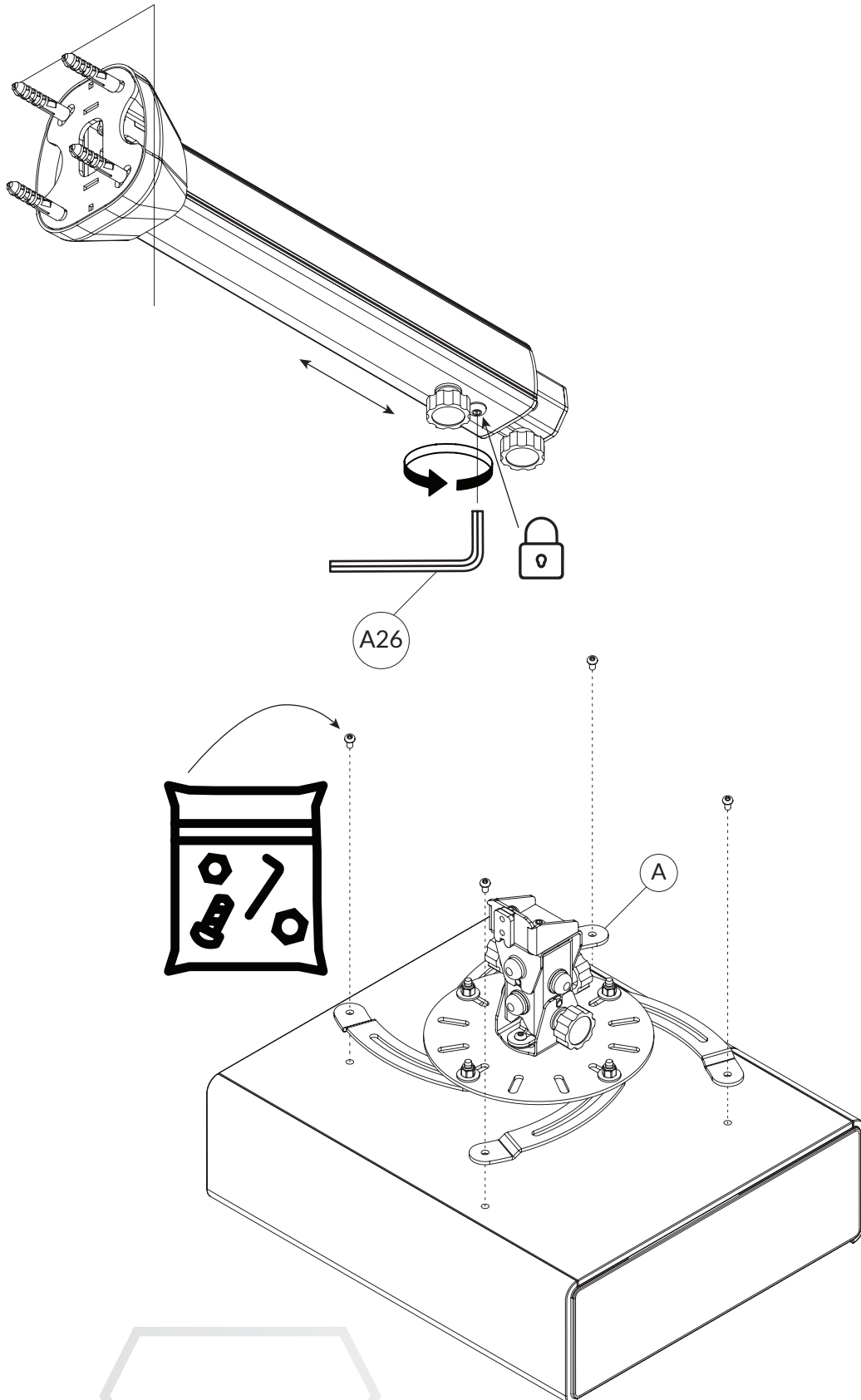

3.

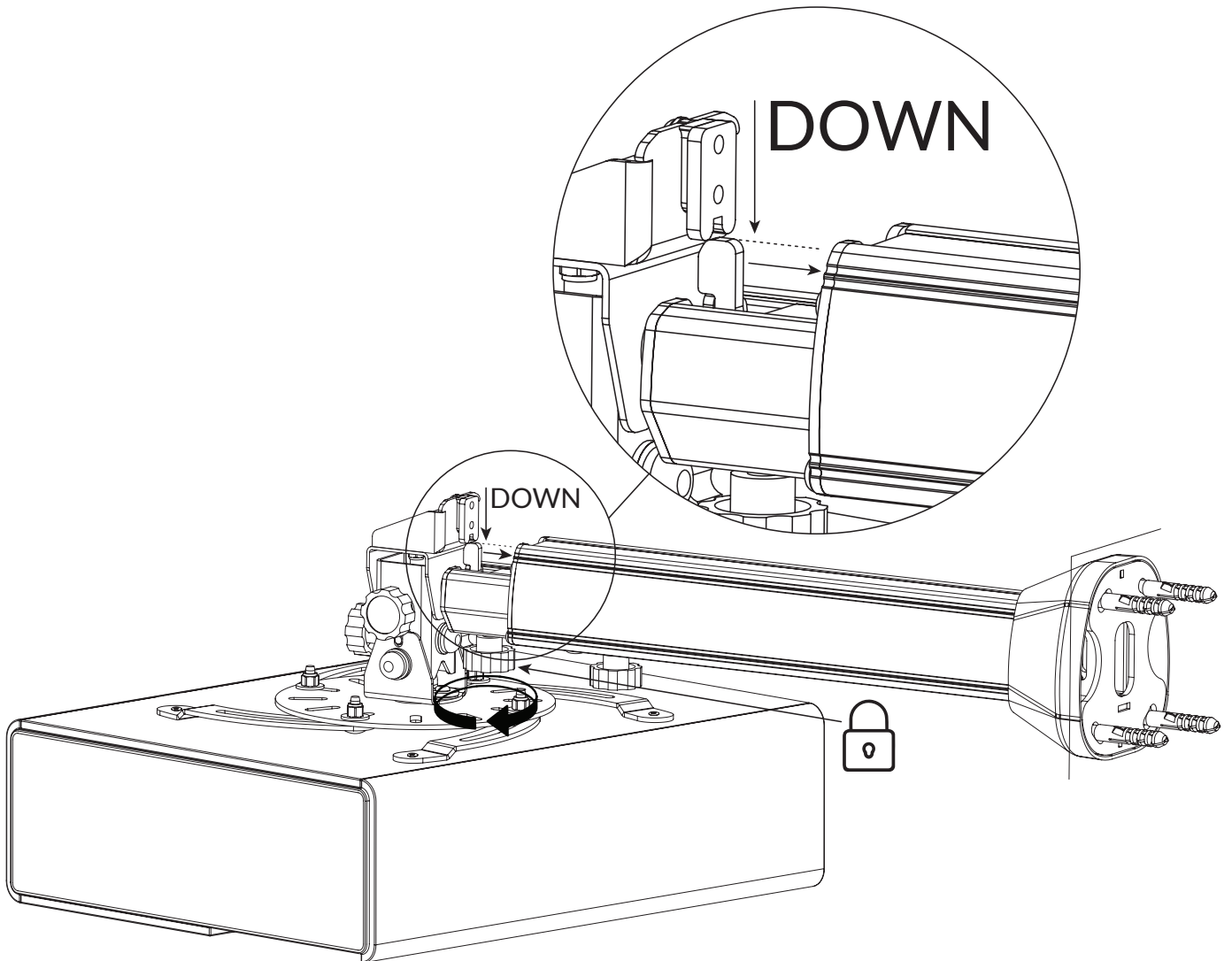

4.

