

49.550

Addit monitor riser - adjustable 550

Because it's height adjustable in five small steps, this riser suits practically everyone. It helps to avoid RSI or CANS and has a maximum weight capacity of 15 kg. Combine it with an in-line document holder for maximum effectiveness.

- Suitable for monitors up to 15 kg
- 5 mm thick clear acrylic
- Saves desk space
- Height adjustable from 70 - 130 mm in 4 steps of 15 mm
- Dimensions (w x d x h): 320 x 256 x 70 - 130 mm

addit

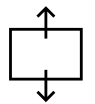
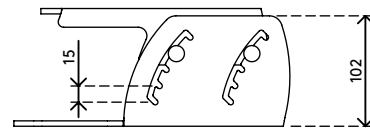
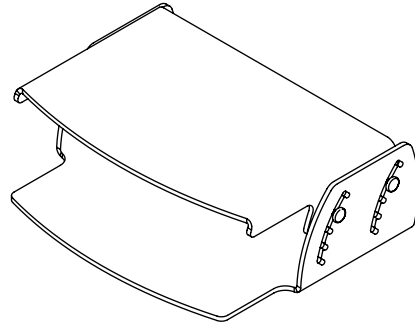
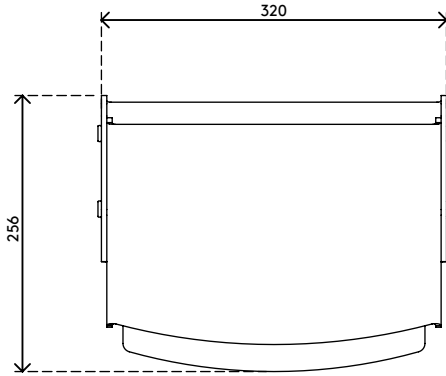

60 mm (2,3")



15 kg

Addit monitor riser - adjustable 550

2016/03/25

49.550

 375 x 295 x 115 mm

 1 pcs

 clear acrylic

 1,45 kg

 805410495503