

Description

The 'Eve glass mount kit' is a customized solution to elegantly mount your iPad on a glass surface, using the Eve mounts by Basalte. This product contains the mounting kit itself and the optional customisation of a cable opening in the Eve cover.

- The glass mount solution is the combination of strong adhesive transfer tape installed on the Eve frame and a self-adhesive cover film to hide the back of the frame. The film is available in a black or white finish and should be applied on the glass prior to installing the Eve.
- The optional customization is for when you need to run the charging cable to an external power source, hidden nearby. We can custom machine a cable opening on the left/right side or the bottom of the cover.



Installing instructions

The 'Eve glass mount kit' should be applied to a glass surface which is clean, dry and free from grease, dirt or other contaminants.

- ⚠ Exposure to direct sunlight might reduce the bond strength of the Eve glass mount kit. It might also increase the temperature of the glass, which might lead to increased risk of glass breakage. Therefore we strongly advise to apply the Eve glass mount kit only on interior glass which is not exposed to direct sunlight.
- ⚠ The Eve wall mount can only be installed vertically with the cover on the bottom or horizontally with the cover on the left side.

Set-up process glass mount kit

- 1 The glass surface must be cleaned thoroughly before applying the adhesive film. Cleaning methods:
 - a. Washing with a mild detergent solution, after which the surface should be rinsed and dried with a lint free cloth.
 - b. Wiping with a solvent-saturated cloth, until all dirt and/or grease has been removed.The 'Eve glass mount kit' should be applied to a glass surface which is clean, dry and free from grease, dirt or other contaminants.

- 2 Verify the exact position of the Eve before applying the film. Use masking tape to position the film on the window and follow next steps accordingly to the drawings.

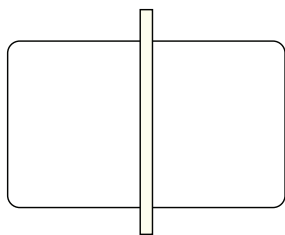

Align sticker on surface and apply tape in centre

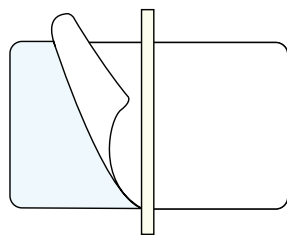

Peel the backing of the sticker

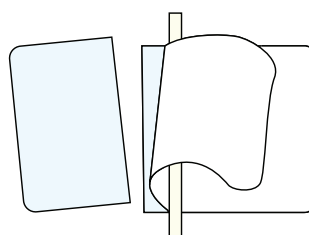

Carefully hold up the sticker while cutting the backpaper

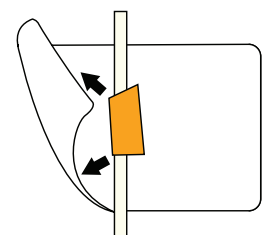

Gently stroke away from the centre with a small ruler

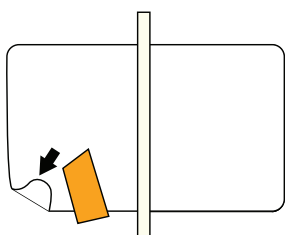

Be careful and don't scratch the sticker while stroking !!!

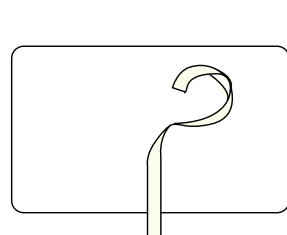

Remove the tape

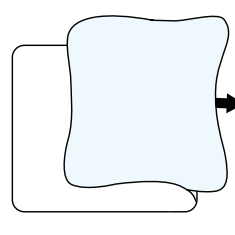

Peel the rest of the backing of the sticker

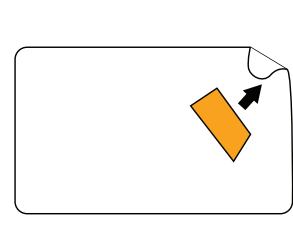

Gently stroke the rest of the sticker away from the centre with the ruler

- 3** Lay the Eve frame on a steady, flat surface with the front facing the surface to remove the protective paper liner from the adhesive tape.



- 4** Carefully mount the Eve frame against the installed film on the glass surface. Make sure that the edges of the film and mount match.

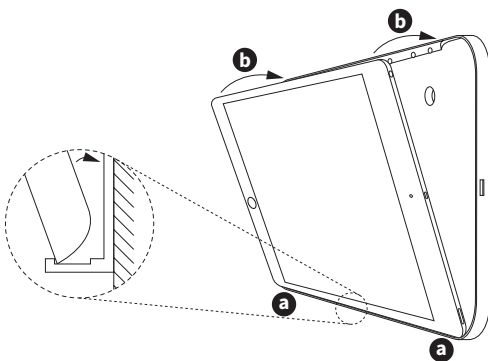

- 5** Landscape mounting:
Place the right side of the iPad in the lower side of the frame as shown on drawing (a) (opposite side of the magnets). Then gently push the iPad in the frame so that it is being held by the magnets (b).
Connect the native charging cable to the iPad.
Portrait mounting:
Place the right side of the iPad in the right side of the frame as shown on drawing 6 (a) (opposite side of the magnets). Then gently push the iPad in the frame so that it is being held by the magnets (b).

- 6** Run the cable through the opening in the cover and click the cover on the frame.

- 7** security cover
Use the attached locking tool to secure your iPad against unwanted removal.

