



B-TECH AV MOUNTS™

**EASY
TORSION-TILT
SYSTEM**

BT8431

UNIVERSAL FLAT SCREEN WALL MOUNT WITH TILT

Designed to mount medium to large sized screens, the BT8431 is a flat screen wall mount that features a unique 'Torsion-Tilt' mechanism which allows easy tilt adjustment of the screen up to +/-15°. Also suitable for pole mounting using B-Tech's Accessory Collars, the BT8431 features levelling screws to adjust the screen level post installation as well as locking screws which help prevent unauthorised removal of the screen.

SPECIFICATION

Recommended screen size	39" - 55"
Max load	50kg
VESA® compatibility	up to 400 x 400
Universal fixings	up to 468mm x 400mm
Tilt adjustment	+/-15°
Distance from wall (flat)	81mm
Distance from wall (full tilt)	148mm
Colour	Black

FEATURES

- Unique 'Torsion-Tilt' mechanism for easy tilt adjustment
- Post installation screen alignment for perfect screen positioning
- Compatible with B-Tech's collar and pole system for pole mounting screens
- Arms feature levelling screws to adjust the screen height
- Safety screws help prevent unauthorised removal of screens
- Simple 'hook-on' installation
- All mounting hardware included



Unique 'Torsion-Tilt' mechanism allows for easy tilt adjustment up to +/-18°

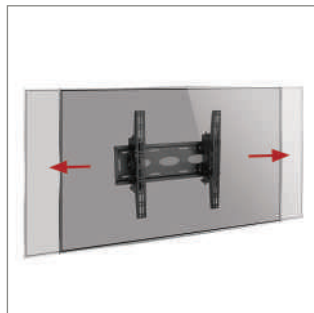

Post installation lateral screen alignment for perfect screen positioning

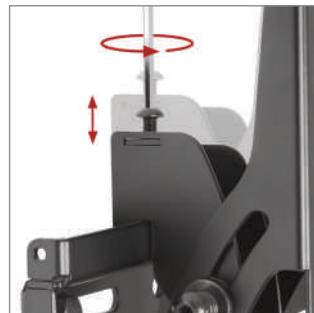

Arms feature levelling screws to adjust the screen height once mounted



Security locking screws and Allen key provided for a secure installation