

Vogel's

Connect-It II - PUC 1090

Technische Zeichnung

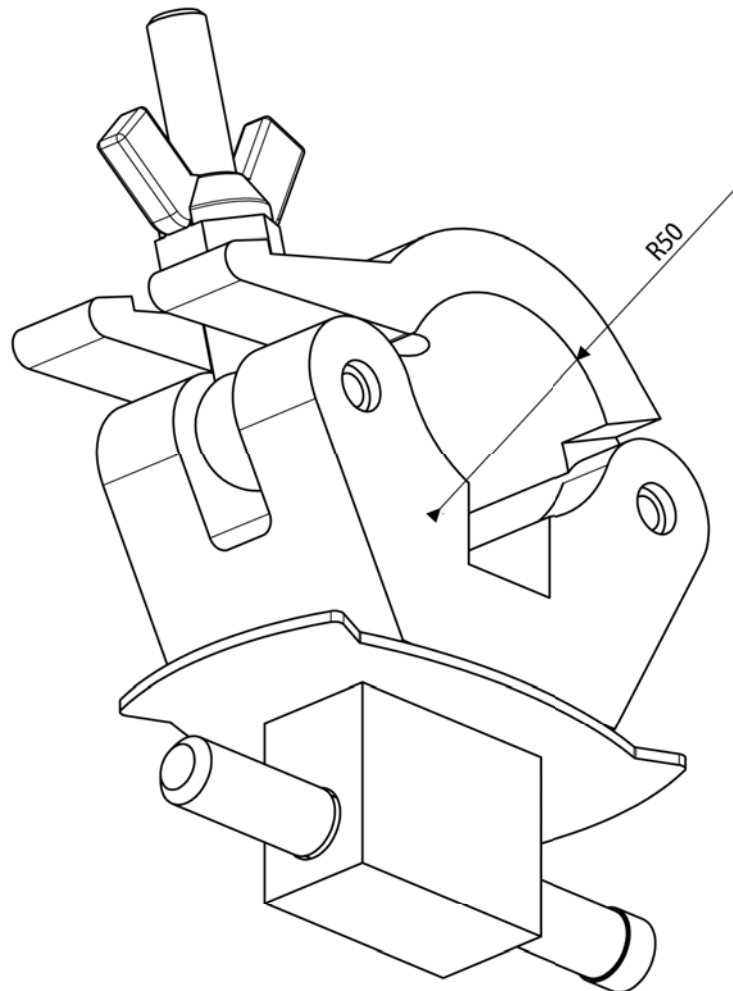

[Alle Angaben in mm]