

Vogel's Connect-It II - PFS 3304

Technische Zeichnung

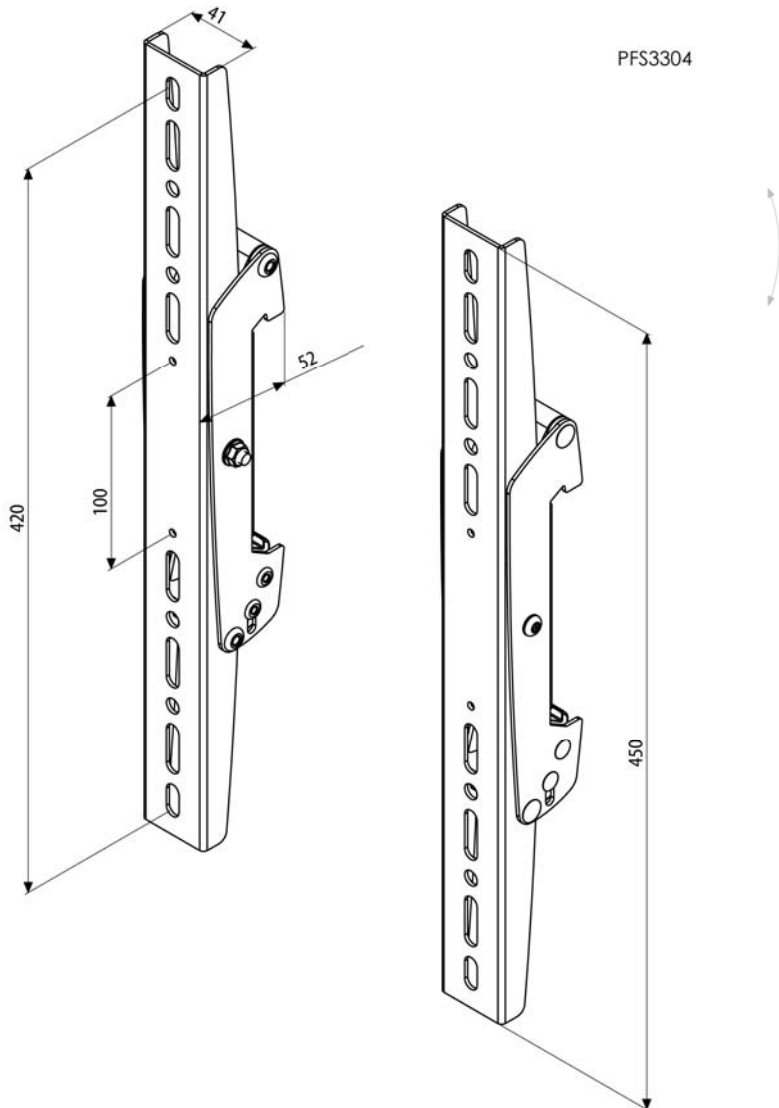

[Alle Angaben in mm]