

CareFit™ Combo Arm with worksurface

WEIGHT CAPACITY

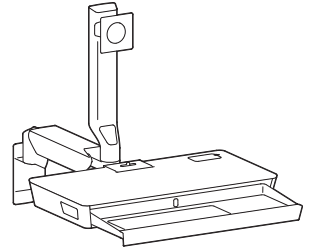

RANGE OF MOTION

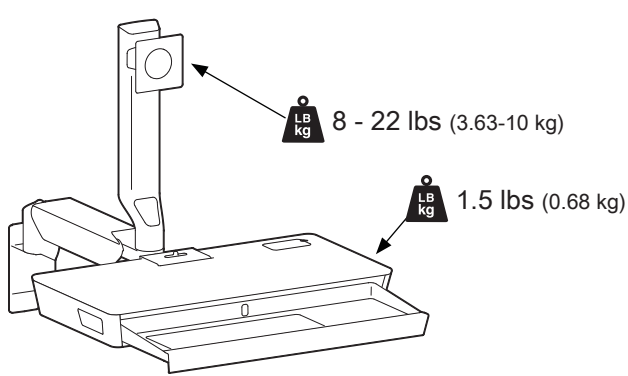
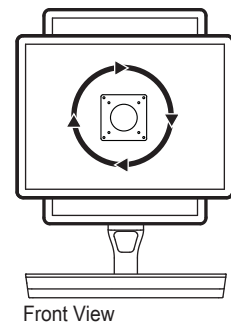
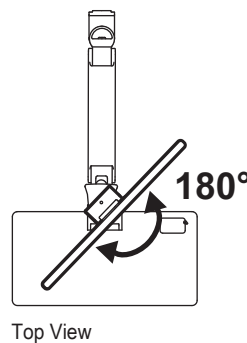
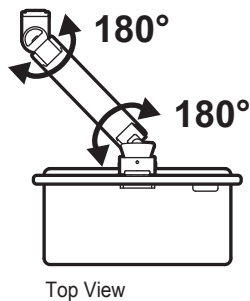
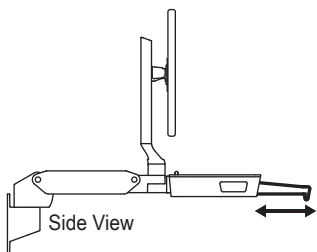
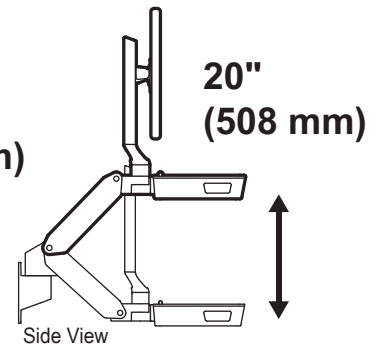
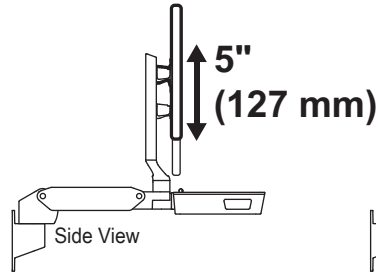
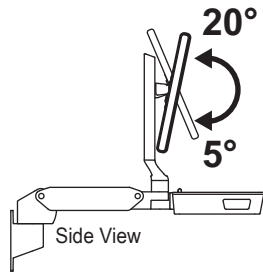
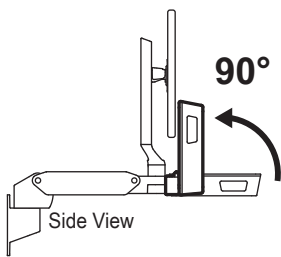

Download additional resources at ergotron.com

USA & Canada Sales & Corporate Headquarters: St. Paul, MN USA / 800.888.8458 / +1.651.681.7600 / insidesales@ergotron.com

EMEA Sales: Amersfoort, The Netherlands / +31.33.45.45.600 / info.eu@ergotron.com

APAC Sales: Sydney, Australia / apaccustomerservice@ergotron.com

LATAM Sales: Mexico / +1.800.681.1820 / info.latam@ergotron.com

Worldwide Custom Sales: custom@ergotron.com

Ergotron devices are not intended to cure, treat, mitigate or prevent any disease. Patent information available at www.ergotron.com/patents

© 2022 Ergotron, Inc. rev. 05/11/2022 DIM-CFArmWS Content is subject to change without notification

CareFit™ Combo Arm with worksurface

DIMENSIONS

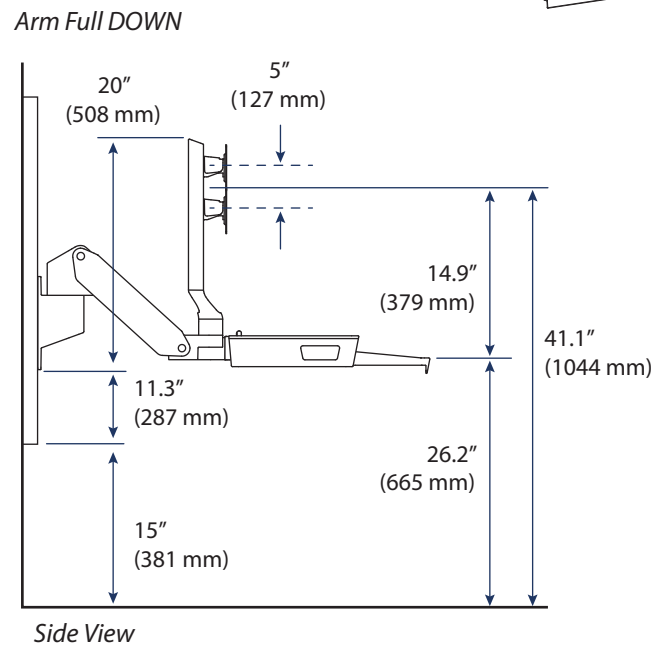
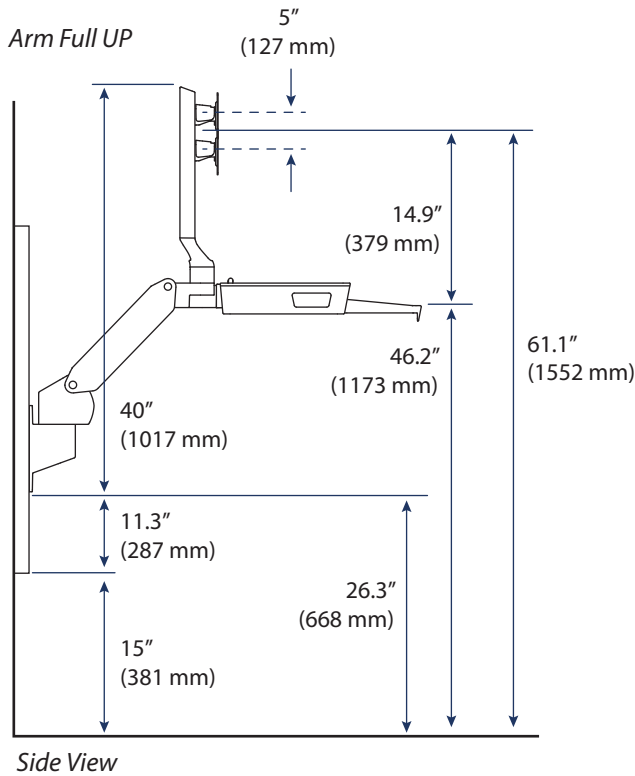
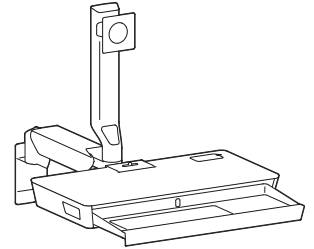

Fully Extended

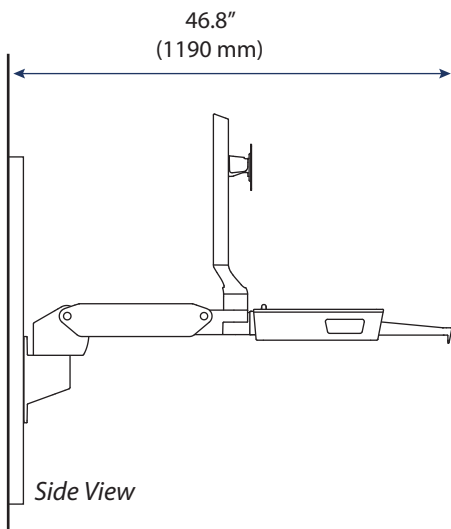

Folded Up Against Wall

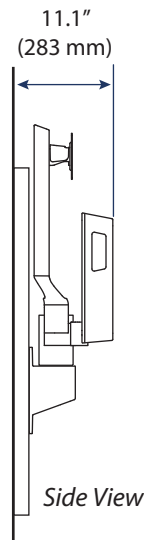

VESA Monitor Bracket

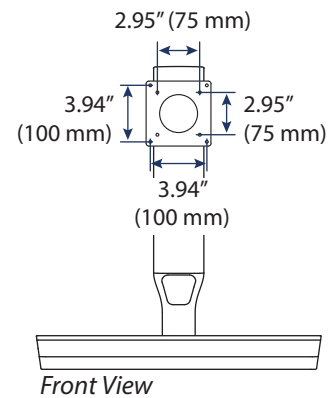

CareFit™ Combo Arm with worksurface

DIMENSIONS

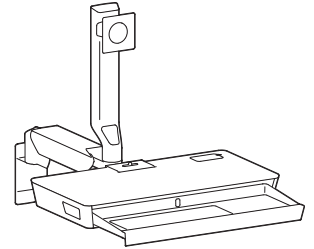

Folded Up Against Wall

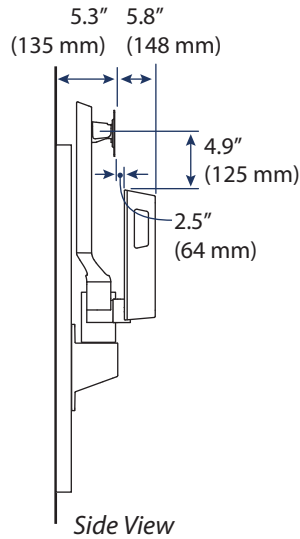

Fully Extended

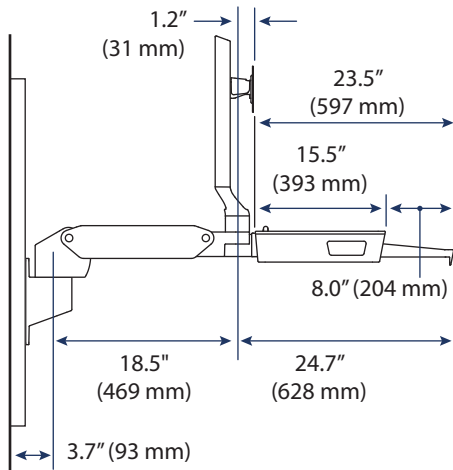

Side View

Keyboard Tray

Extra Cable and Power Brick Storage:
6.8\"W x 3.2\"D x 2.6\"H (172W x 80D x 66H mm)

RFID Badge Scanner Holder:
3.9\"W x 2.6\"D x 0.8\"H (98W x 66D x 21H mm)

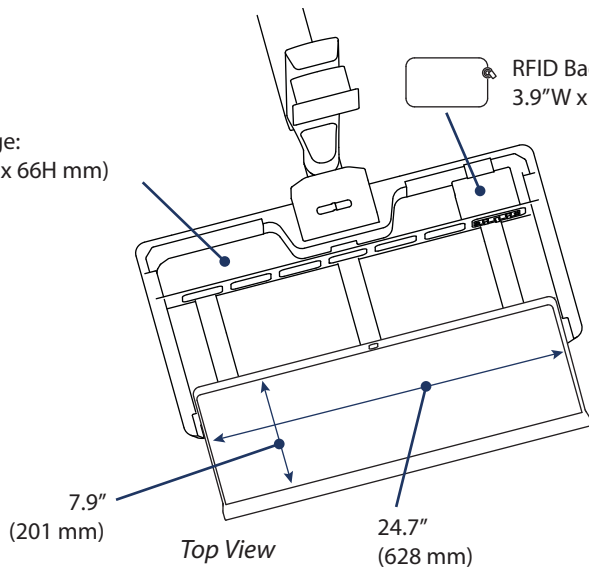

Top View

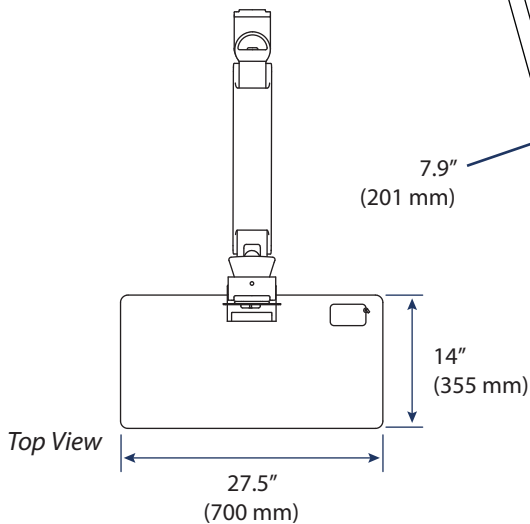

Top View

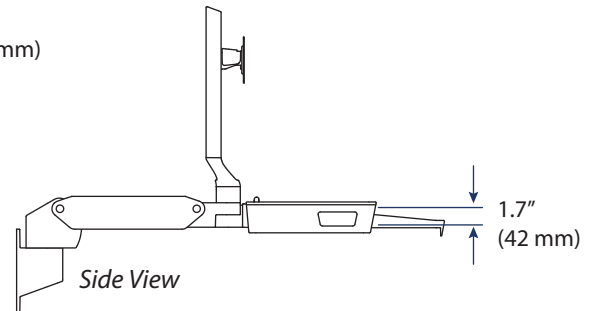

Side View

CareFit™ Combo Arm with worksurface

DIMENSIONS

Pushed back against the wall

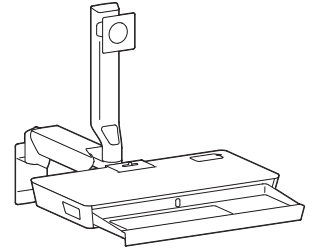
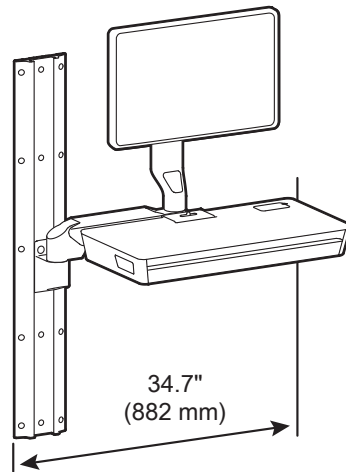

MOUNTING OPTIONS

The CareFit Combo Arm mounts to the Ergotron Wall Track.

CABLES

Cable length needed based on equipment and accessories:

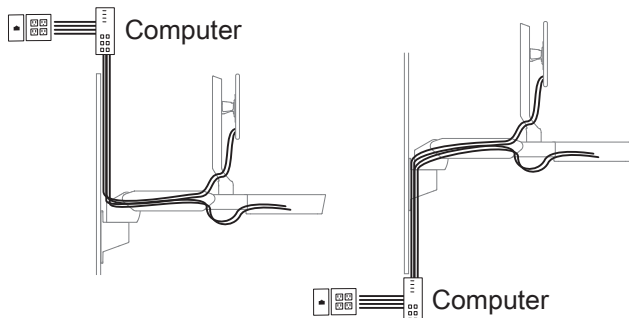

Cables:

- HDMI: 6' (1.8 m)
- Ethernet: 6' - 10' (1.8-3 m)
- Monitor Power: 6' - 10' (1.8-3 m)
- 2.0 USB Extenders: 6' (1.8 m) per accessory

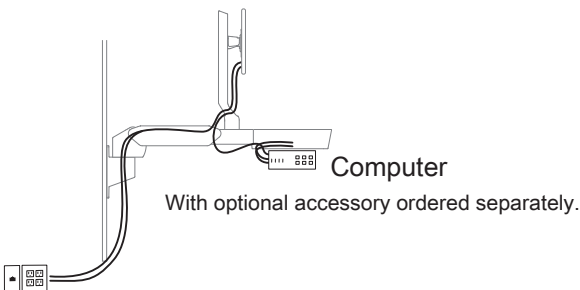

Cables:

- HDMI: 4' (1.2 m)
- Ethernet: 6' - 10' (1.8-3 m)
- Monitor Power: 6' - 10' (1.8-3 m)
- Computer Power: 6'-10' (1.8-3 m)

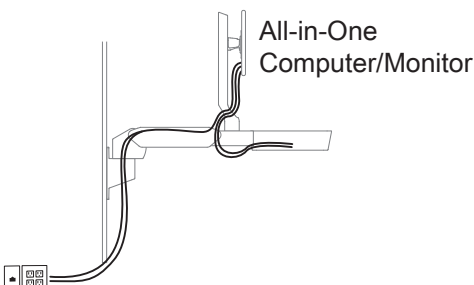

Cables:

- Ethernet: 6' - 10' (1.8-3 m)
- Monitor Power: 6' - 10' (1.8-3 m)