

viewlite X

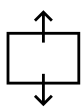

350 mm (13,8")

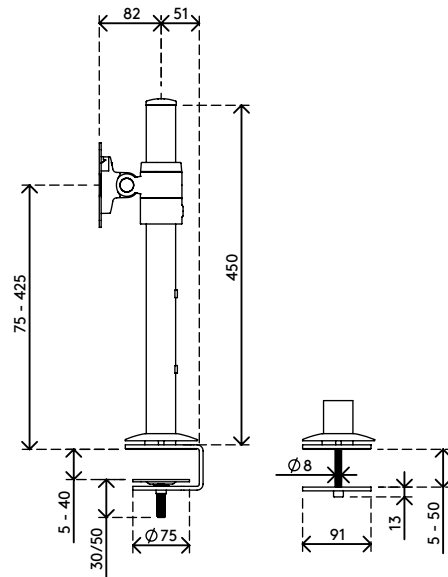
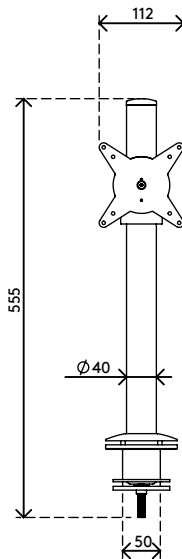
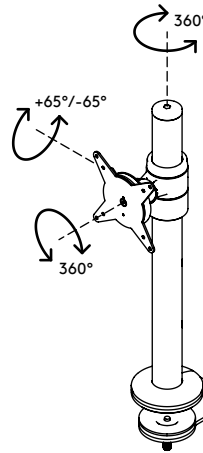
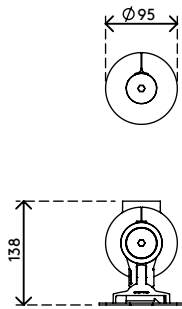

+65°/-65°

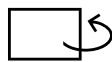

360°



360°



816 mm (32,1")



75 x 75/100 x 100



8 kg

Viewlite Monitorarm - Schreibtisch 103

2019/06/24

58.103

 610 x 180 x 120 mm

 1 pcs

 schwarz

 3 kg

 805410581039