



TECHNICAL SPECIFICATION SHEET

PRODUCT NAME: Oripura Laptop Stand

PRODUCT CODE: LAP/013

Doc Rev 2.

02.04.21 LE

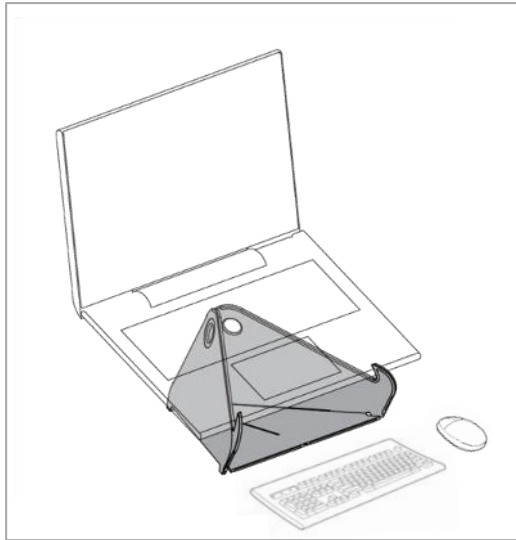

Product configured with laptop

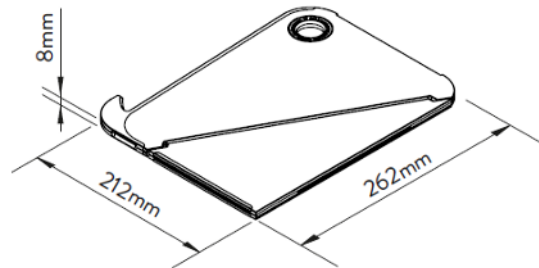
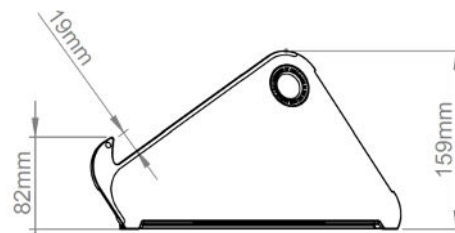
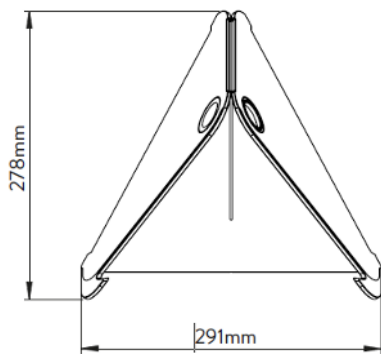
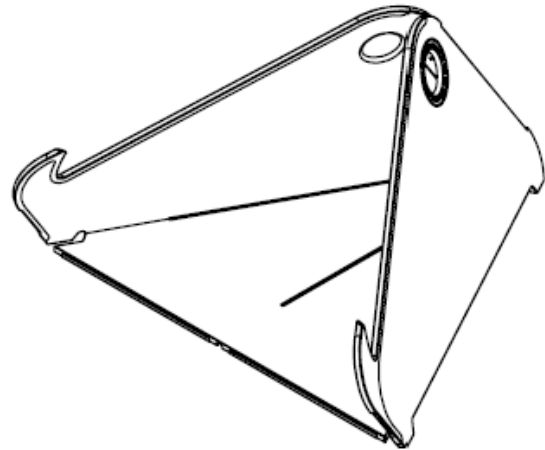

KEY FEATURES

- Free standing solution that allows laptops to be elevated off the work surface to create an ergonomic workstation* at the office, at home or on the go.
- Supports laptops up to 16" screen size.
- Folds down flat for easy storage and transportability in laptop bag or briefcase.
- No installation required.
- Non-slip material along the sides and bottom keep laptop stable and protect surfaces from damage.
- Built-in cable management helps keep worksurface neat and tidy.
- Available in white.

*Product requires the use of a separate keyboard and mouse.

Max load	2.8kg (6.2lb)
Laptop screen size	Up to 16"
Total product recyclable	100%
Product Packaging	100% plastic-free

LOGISTICAL

Pack contains	Oripura Laptop Stand
Product net weight:	0.41 kg
Pack dims (HxWxD)	290 x 240 x 11 mm
Pack gross weight	0.43 kg
Master carton quantity	30 pcs
Master carton dims (HxWxD)	400 x 265 x 300 mm
Master weight	13 kg
Pallet quantity	900 pcs (30 cartons)
Country of origin	UK

ORDERING INFORMATION

Product Description	Product Code	Colour
Oripura Laptop Stand	LAP/013/W	White

WARRANTY

Warranty Term	5 years
----------------------	---------

ENVIRONMENTAL

Material Make-up			Total Recycled Content	Breakdown of Recycled Content		Total Recyclable	
Overall Product			Overall Product			Overall Product	
Material type	Total Material type weight (g)	Percentage of Total Product Weight (%)	Material-Type Recycled Content (%)	Percentage PIR of total weight (%)	Percentage PCR of total weight (%)	Total Product Recyclable (g)	Total Product Recyclable (%)
Plastic	408.6	100.0%	0.0%	0.0%	0.0%	408.6	100.0%
Total	408.6	100.0%	0.0%	0.0%	0.0%	408.6	100.0%

PIR = Post Industrial Recycled
PCR = Post Consumer Recycled

Due to calculation rounding there may be some small variations in displayed percentage totals.

Total Product Weight (%)

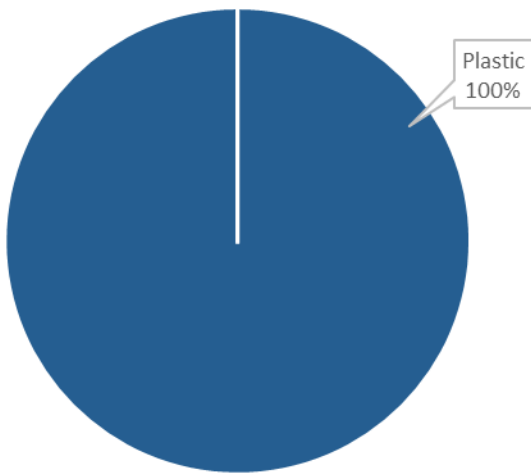

Total Product Recyclable Content (%)

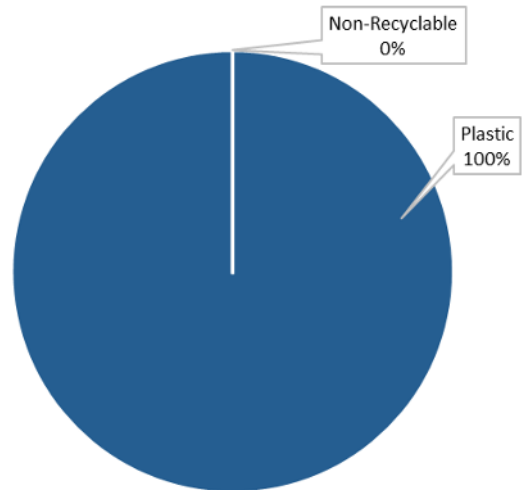

Product packaging is 100% plastic-free.

CLEANING, STORAGE & MAINTENANCE

Routine servicing	Periodic inspection
Service components	Available to order
Cleaning & Maintenance	Damp cloth, no abrasives, no solvents to be used on the cosmetic surfaces
Handling & Storage	Do not drop or expose to moisture

While every effort is made to ensure the accuracy of our technical information, Colebrook Bosson Saunders (Products) Ltd accept no liability for the accuracy of the information contained in this document and reserve the right to modify the specifications or data contained herein without prior notification.